

Managed Networking Configuration

Q-M-4800-24P-L3-4S-V	Q-M-4800-48P-L3-4S-V	Q-IE-6600-28P-L3-4G-E	Q-IE-6600-48P-L3-4G-E
Q-EP-9300-24P-L3-4G	Q-EP-9300-48P-L3-4G	Q-IE-9600-24P-L3-4G-E	Q-IE-9600-48P-L3-4G-E

16 MAY 2017

V1.0

QUANT INTERNATIONAL SDN. BHD. © 2022

Copyright © 2022 QUANT INTERNATIONAL SDN. BHD. All rights reserved.

Without the prior written permission of QUANT INTERNATIONAL SDN. BHD., no part of this manual may be reproduced, distributed, or transmitted in any form or by any means.

This includes copying, extracting, backing up, modifying, distributing, translating into other languages, or using this document in whole or in part for commercial purposes.

Introduction	4
Readership.....	4
Case 1 Achieved communication between different VLAN through switch.....	5
Case 2 Configuration of Static Router	8
Case 3 VLAN Configuration	11
Case 4 QINQ Configuration	12
Case 5 Port Isolation.....	15
Case 6 Static Aggregation.....	16
Case 7 LACP Configuration	17
Case 8 STP/ RSTP/ MSTP Configuration.....	19
Case 9 MSTP multi-instance mapping VLAN configuration.....	21

Revision record

Date	Version	Description
2017-05-16	V1.0	First Version
2017-11-13	V1.1	Add QinQ Configuration

Introduction

Readership

The manual is applicable to installers and system administrators who is responsible for installing, configuring, or maintaining the network, and assumes that the users understand all network usage of transmission and management protocols.

The manual also assumes that the users are familiar with related to networking equipment, protocols and interfaces, theoretical principles, practical skills, and specific expertise. Meanwhile the users must also have work experience of operating graphical user interfaces, command line interfaces, simple network management protocols and Web browser.

Case 1 Achieved communication between different VLAN through switch

It needs to Configure L3 routing function to achieve communication between different network segments.

1. Topology:

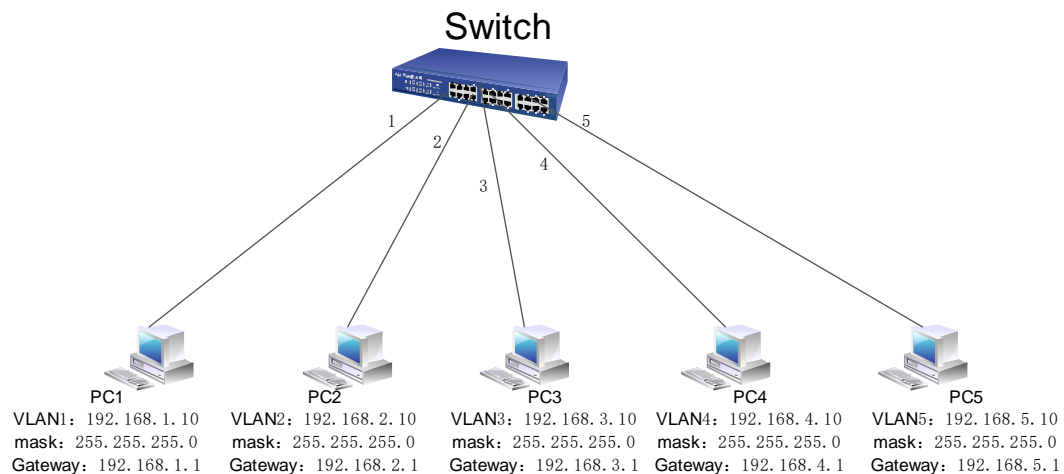

2. Configuration step for switch

A. Create VLAN1-5 and set them to vlan1-5 respectively.

```
# con t
(config)# hostname switch
switch(config)# vlan 1-5
switch(config-vlan)# exit
switch(config)# int GigabitEthernet 1/2
switch(config-if)# switchport access vlan 2
switch(config-if)# int GigabitEthernet 1/3
switch(config-if)# switchport access vlan 3
switch(config-if)# int GigabitEthernet 1/4
switch(config-if)# switchport access vlan 4
switch(config-if)# int GigabitEthernet 1/5
switch(config-if)# switchport access vlan 5
```

1, B. Set the switch to router mode, and set the IP, VLAN1:192.168.1.1, VLAN2: 192.168.2.1, VLAN3: 192.168.3.1, VLAN4: 192.168.4.1, VLAN5: 192.168.5.1。

```
switch(config)# ip routing
```

```
switch(config)# int vlan 1
```

```
switch(config-if-vlan)# ip address 192.168.1.1 255.255.255.0
```

```
switch(config-if-vlan)# int vlan 2
```

```
switch(config-if-vlan)# ip address 192.168.2.1 255.255.255.0
```

```
switch(config-if-vlan)# int vlan 3
```

```
switch(config-if-vlan)# ip address 192.168.3.1 255.255.255.0
```

```
switch(config-if-vlan)# int vlan 4
```

```
switch(config-if-vlan)# ip address 192.168.4.1 255.255.255.0
```

```
switch(config-if-vlan)# int vlan 5
```

```
switch(config-if-vlan)# ip address 192.168.5.1 255.255.255.0
```

3. Configure IP, mask and gateway of PC1, same setting way for PC2 - PC5.

Click “ local connection - properties - TCO/IPV4 - properties - confirm”

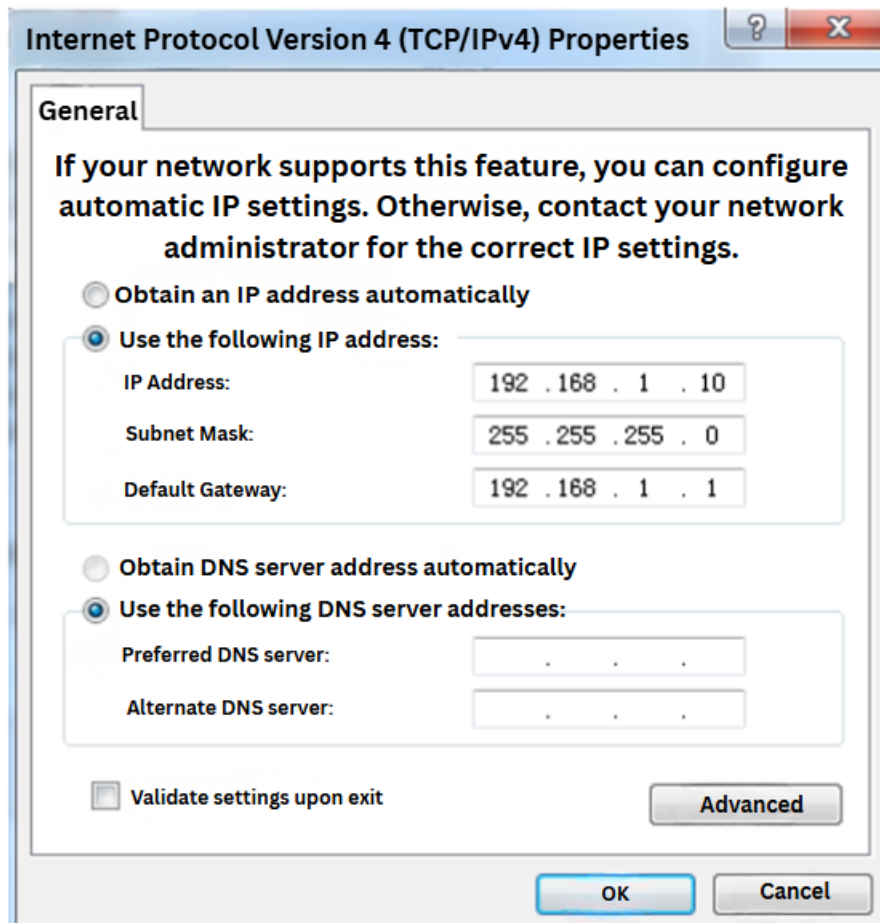

4. Testing the communication result between PC1-PC5.

Case 2 Configuration of Static Router

It needs to Configure static router or default router function of the switch to achieve communication between different network segments.

1. Topology:

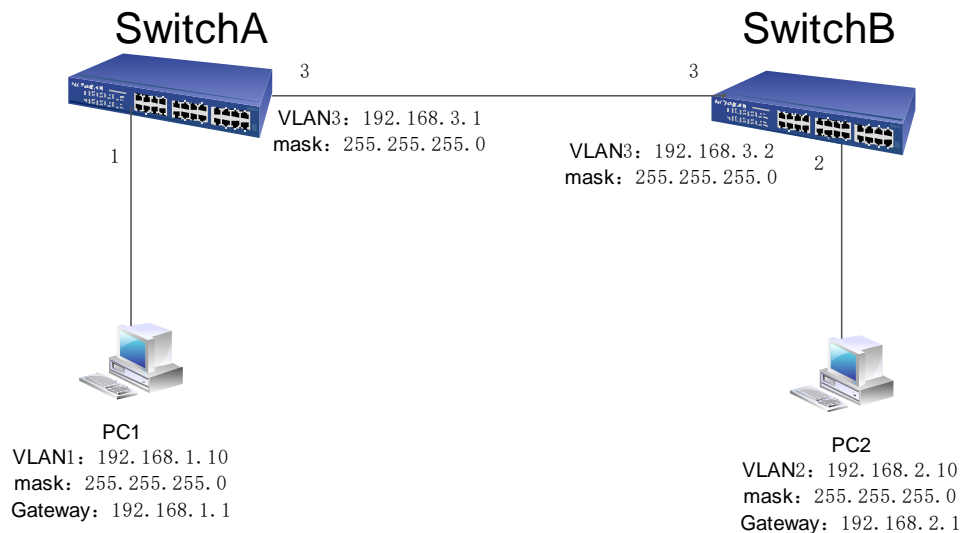

2. Configuration step of switch

A. Create VLAN1, VLAN3, PORT 1, PORT 3 in switch A and set them to VLAN 1 VLAN 3 respectively.

```
switch# con t
switch(config)# hostname switchA
switchA(config)# vlan 1-3
switchA(config-vlan)#
```

B. Create VLAN2, VLAN3, PORT 2, PORT 3 in switch B and set them to VLAN 2 VLAN 3 respectively.

```
switch# con t
switch(config)# hostname switchB
switchB(config)# vlan 1-3
switchB(config-vlan)#
```

C. Configure Switch A to router mode, set IP, VLAN1:192.168.1.1, VLAN3: 192.168.3.1

And Configure static router IP

```
switch(config)# ip routing
```

```
switch(config)# int vlan 1
```

```
switch(config-if-vlan)# ip address 192.168.1.1 255.255.255.0
```

```
switch(config-if-vlan)# int vlan 3
```

```
switch(config-if-vlan)# ip address 192.168.3.1 255.255.255.0
```

```
switch(config)#ip route 0.0.0.0 0.0.0.0 192.168.3.2
```

D. Configure Switch B to router mode, set IP, VLAN1:192.168.2.1, VLAN3: 192.168.3.2

And Configure static router IP

```
switch(config)# ip routing
```

```
switch(config)# int vlan 2
```

```
switch(config-if-vlan)# ip address 192.168.2.1 255.255.255.0
```

```
switch(config-if-vlan)# int vlan 3
```

```
switch(config-if-vlan)# ip address 192.168.3.2 255.255.255.0
```

```
switch(config)#ip route 0.0.0.0 0.0.0.0 192.168.3.1
```

3. Configure IP, mask and gateway of PC1, same setting way for PC2.

Click “ local connection - properties - TCO/IPV4 - properties - confirm”

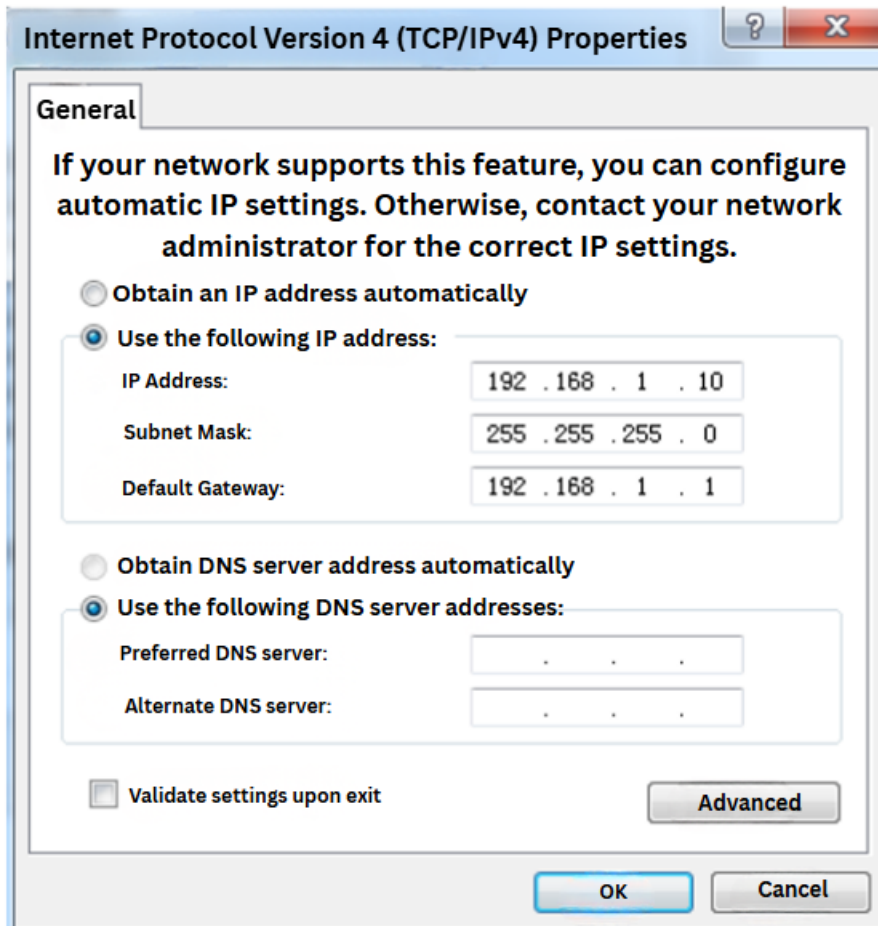

4. Testing the communication result between PC1-PC2.

Case 3 VLAN Configuration

To enable the link between Switch A and Switch B to support user communication under VLAN2 and user communication under VLAN3, you need to configure the connection interface to add two vlans at the same time. Namely the Ethernet interface ge1/3 of switch A and Ethernet interface ge1/3 of switch B should be added in VLAN2 and VLAN3 at the same time.

1. Topology

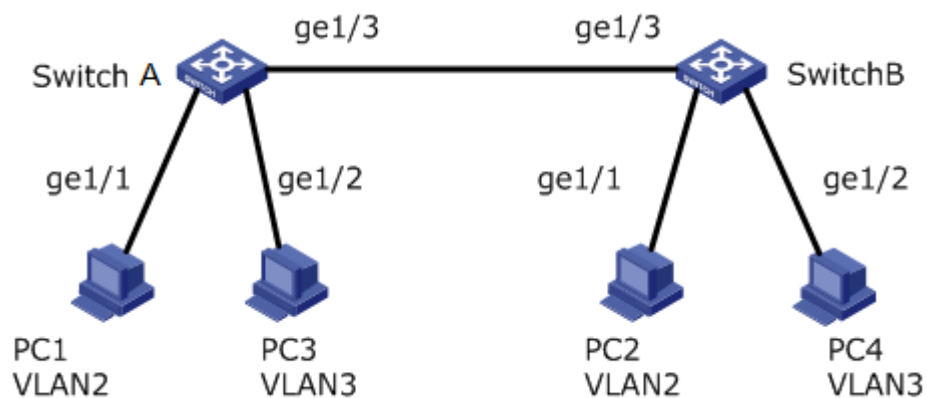

2. Configuration step of switch

A. Create VLAN2 and VLAN3 in Switch A and add the user's connection interface into VLAN respectively, and set ge1/3 to the trunk mode. Click the "Advanced Configure > VLANs", enter the "VLANs" interface, fill in the corresponding configuration items, click "SAVE" to complete the configuration. The same configuration way for Switch B. switch#

```
switch(config)# hostname switchA
```

```
switchA(config)# vlan 1-3
```

```
switchA(config-vlan)#
```

```
switch(config-vlan)# exit
```

```
switch(config)# int GigabitEthernet 1/1
```

```
switch(config-if)# switchport access vlan 2
```

```
switch(config-if)# int GigabitEthernet 1/2
```

```
switch(config-if)# switchport access vlan 3
```

```
switch(config-if)# int GigabitEthernet 1/3
```

```
switch(config-if)# switchport mode trunk
```

B. Testing configuration result

Configure PC1 and PC2 into a same network segment, such as 192.168.100.0/24;

Configure PC3 and PC4 into a same network segment, such as 192.168.200.0/24.

PC1 and PC2 can ping each other, but they cannot ping PC3 and PC4. PC3 and PC4 can ping each other, but they can't ping PC1 and PC2.

Case 4 QINQ Configuration

There are two enterprises in the network, enterprise 1 has two branches, and enterprise 2 has two branches. The network of each of the two enterprises is connected to the Switch A and Switch B in the operator network respectively, and there are other manufacturers in the public network, and the TPID value of the outer VLAN Tag is 0x9100.

Now it needs to be realized:

- Set independent division of VLAN for enterprise 1 and 2, both can't influence each other.
- Data transparent transmission between two branches of each enterprise. Intercommunication for same business, isolation for different business.

It can be achieved through configuring QinQ to above demands. Using the VLAN100 provided by the public network to enable the enterprise1 to intercommunicate with each other. Using the VLAN200 provided by the public network to enable enterprise 2 to intercommunicate with each other. And separate different enterprises from each other. By configuring the TPID value of QinQ outer VLAN Tag on the interface connect with the device of other manufacturers to achieve the intercommunication with other manufacturers equipment.

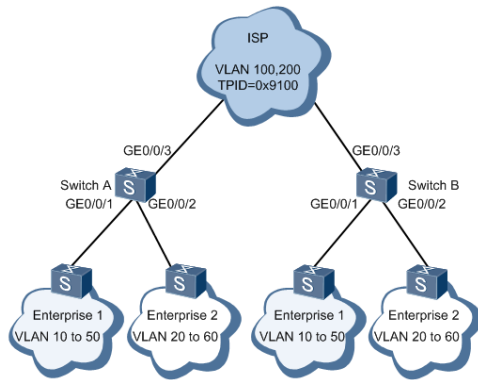

Configuration Idea

1. VLAN 100 and VLAN 200 both in switch A and switch B, configure the interfaces connected network services to QinQ type, and add into VLAN respectively. It enables different services add different outer layer VLAN Tag.
2. Configure interface connected with public network added into corresponding VLAN in switch A and switch B. And enable traffic communication between VLAN 100 and 200.
3. Configure TPID value of outer layer VLAN tag of interfaces connected with public network in switch A and switch B, enable communication with other brand equipment.

Configuration Steps

1. Create VLAN

#Create VLAN 100 and VLAN 200 in switch A

```
switch(config)# vlan 100,200
```

#Create VLAN 100 and VLAN 200 in switch B, same as above

2. Configure the interface type to QionQ

#Configure interface GE0/0/1 and GE0/0/2 to QinQ type in switch A. And outer layer tag of GE0/0/1 is VLAN 100, outer layer tag of G0/0/2 is VLAN 200

```
switch(config)# interface GigabitEthernet 1/1
```

```
switch(config-if)#switchport hybrid native vlan 100
switch(config-if)#switchport hybrid port-type unaware
switch(config-if)#switchport mode hybrid
switch(config)# interface GigabitEthernet 1/2
switch(config-if)#switchport hybrid native vlan 200
switch(config-if)#switchport hybrid port-type unaware
switch(config-if)#switchport mode hybrid
```

#Configure interface GE0/0/1 and GE0/0/2 to QinQ type in switch B. And outer layer tag of GE0/0/1 is VLAN 100, outer layer tag of G0/0/2 is VLAN 200

3. Configure switch interface connected with public network

#Configure switch A's interface GE0/0/3 added into VLAN 100 and VLAN 200. Same configuration step for switch B.

```
switch(config)# interface GigabitEthernet 1/3
switch(config-if)# switchport hybrid allowed vlan 1,100,200
switch(config-if)#switchport hybrid port-type s-custom-port
switch(config-if)#switchport mode hybrid
```

4. Configure TPID value of outer VLAN tag, same configuration for switch B.

```
switch(config)#vlan ethertype s-custom-port 0x9100
```

5. Testing configuration result

Test if A PC in any VLAN of any branch in enterprise 1 can ping the PC in the same VLAN of any branch in enterprise 1. It indicates that it can intercommunicate in enterprise 1.

Test if A PC in any VLAN of any branch in enterprise 2 can ping the PC in the same VLAN of any branch in enterprise 2. It indicates that it can intercommunicate in enterprise 2.

Test if A PC in any VLAN of any branch in enterprise 1 can ping the PC in the same VLAN of any branch in enterprise 2. If it cant, the communication isolated between enterprise 1

and enterprise 2

Case 5 Port Isolation

Definition of port isolation: there is no communication between the same isolation group
PC1, PC2 and PC3 belong to VLAN10. Users hope that PC1 and PC2 will not be able to
access each other in VLAN10, PC1 and PC3 can be accessed from each other, and PC2
and PC3 can be accessed from each other.

1. Topology

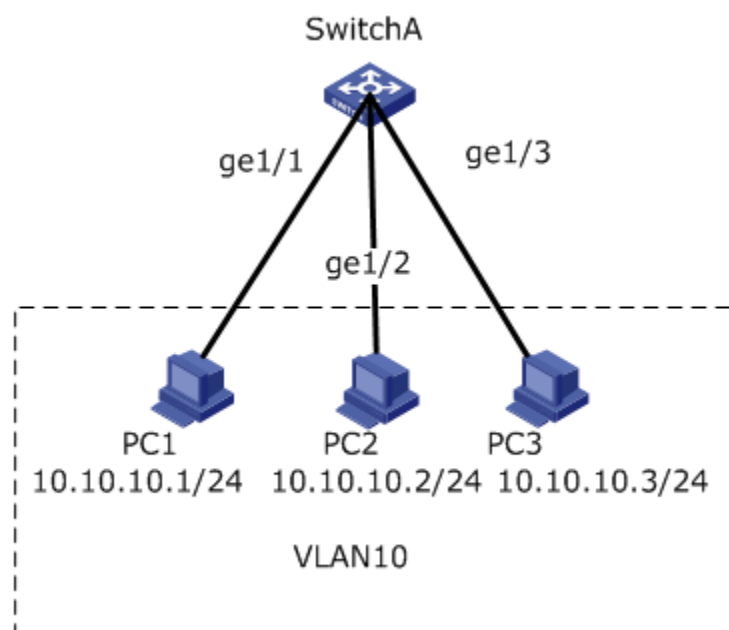

2. Configuration step of switch

A. Create VLAN10 to determine the VLAN of the PC.

```
switch# con t
```

```
switch(config)# hostname switchA
```

```
switchA(config)# vlan 10
```

```
switchA(config-vlan)#
```

```
switchA(config-vlan)# exit
```

```
switchA(config)# int GigabitEthernet 1/1
```

```
switchA(config-if)# switchport access vlan 10
```

```
switchA(config-if)# int GigabitEthernet 1/2
```

```
switchA(config-if)# switchport access vlan 10
```

```
switchA(config-if)# int GigabitEthernet 1/3  
switchA(config-if)# switchport access vlan 10
```

B. Configuration ge1/1, ge1/2 Port Isolation function

```
switch# (config)# int GigabitEthernet 1/1  
switch# (config-if)# pvlan isolation  
switch# (config)# int GigabitEthernet 1/2  
switch# (config-if)# pvlan isolation
```

C. Testing configuration result

```
# PC1 and PC2 cant ping with each other  
# PC1 and PC3 can ping with each other  
# PC2 and PC3 can ping with each other
```

Case 6 Static Aggregation

As shown in the figure below, Switch A and Switch B is connected with the network of VLAN10 and VLAN20 respectively via Ethernet link, and there is a large data traffic between Switch A and Switch B. If users want that there is greater link bandwidth between switch A and switch B to enable communication between each other in the same VLAN.

At the same time, it is able to provide some redundancy to ensure the reliability of data transmission and link.

1. Topology

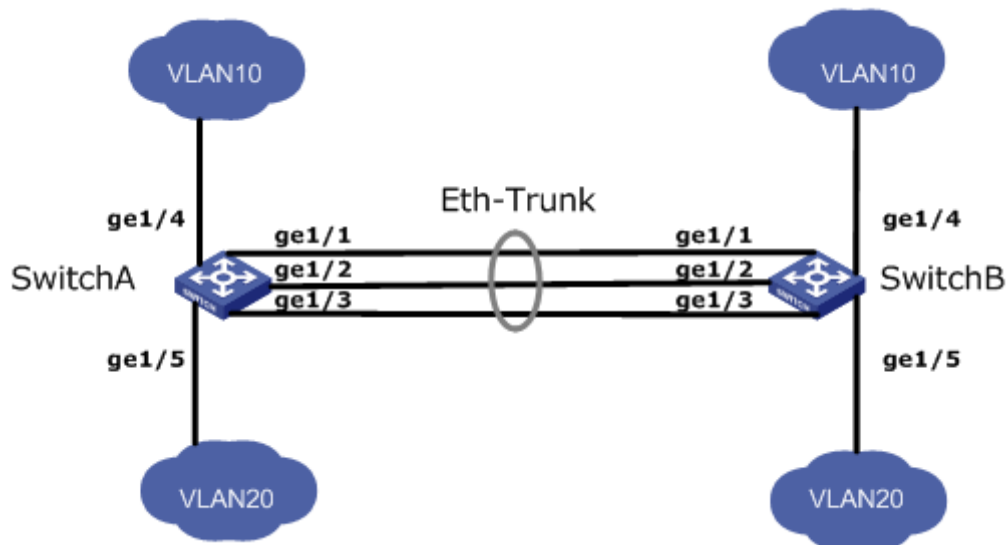

2. Configuration of Switch

A. Create the eth-trunk interface of switch A and add sub interface, aiming to increase the link bandwidth. Same configuration for the switch B.

```
switchA (config)# int GigabitEthernet 1/1-3
switchA(config-if)# aggregation group 1
```

B. Please check case 3 for the reference of VLAN configuration

Case 7 LACP Configuration

Ethernet Switch A USES three ports (GE1 ~ GE3) to aggregation

Then adding the Switch B, to ensure load sharing among sub ports.

In the actual configuration below, dynamic convergence is used for reference.

1. Topology

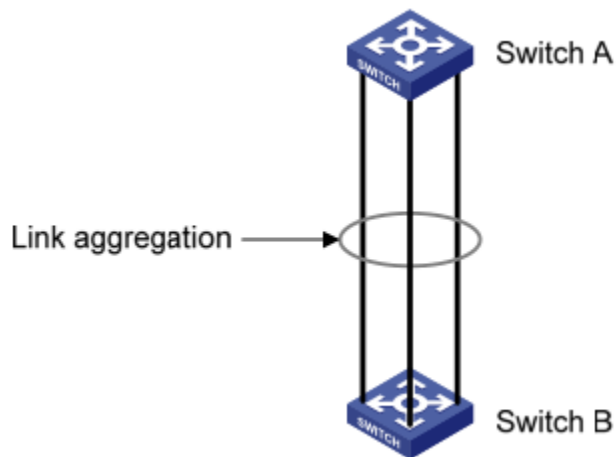

2. Configuration Step of Switch

A. Create the eth-trunk on the Switch A and configure it to be LACP mode, and set the system priority to 100 for the Switch A, making it LACP active terminal.

```
switchA (config)# int GigabitEthernet 1/1-3
```

```
switchA(config-if)# lacp
```

```
switchA(config-if)#lacp port-priority 100
```

B. The Switch B configuration process is similar to the Switch A, with the priority default 32768, which makes it LACP passive end.

```
switchA (config)# int GigabitEthernet 1/1-3
```

```
switchA(config-if)# lacp
```

```
switchA(config-if)# lacp role passive
```

Case 8 STP/ RSTP/ MSTP Configuration

STP (Spanning Tree Protocol) is designed to reduce link failures on the network and prevent loops from providing protection to the network. In complex structural networks it is easy to generate an unconscious loop storm. The switch's MSTP function is enabled by default. The switch supports three versions of generation tree protocol: STP, RSTP, and MSTP. In the following figure, the four switches have the same priority, all of which are 32768. Enable the generation tree protocol to block a port, making the loop a tree structure.

1. Topology

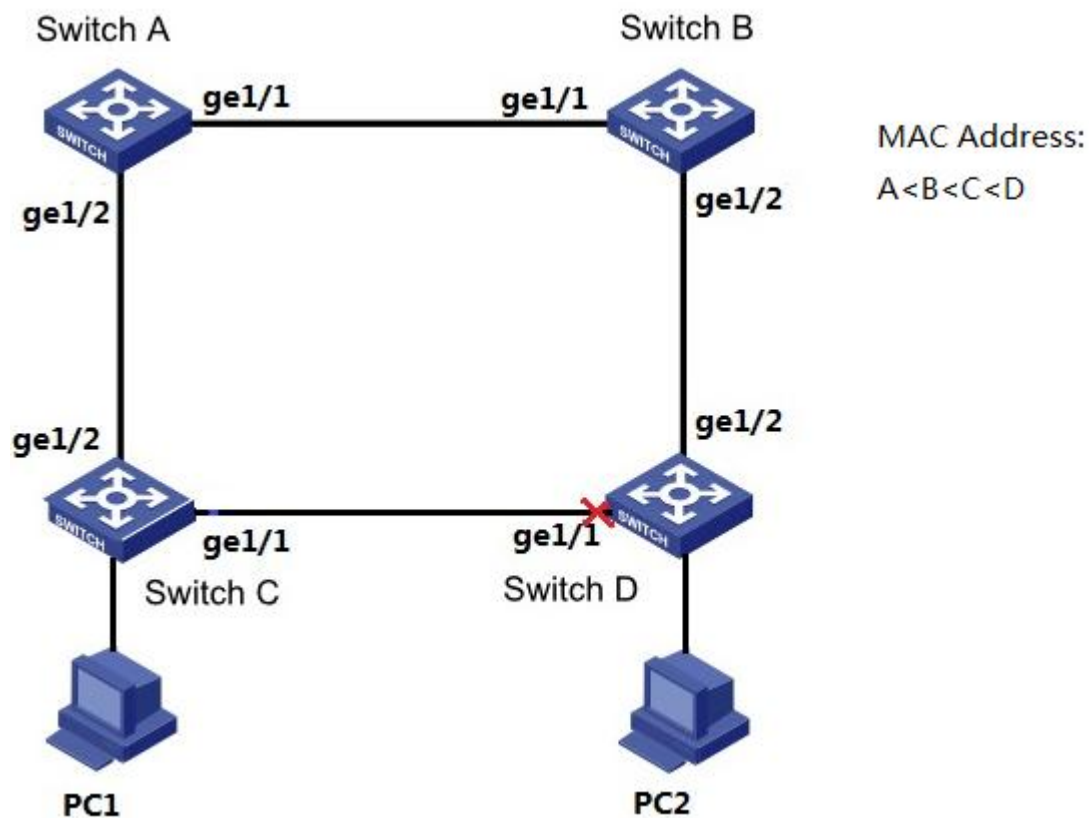

2. Switch Configuration

A. Enable STP under global mode for switch A. Users can choose MSTP, RSTP or STP. Same configuration step for switch B, switch C, switch D.

```
switchA#  
switchA# con t  
switchA(config)# spanning-tree mode rstp
```

B. Enable the STP function of PORT1 and PORT2. Same configuration step for Switch B, Switch C and Switch D.

```
switchA (config)# int GigabitEthernet 1/1-2  
switchA(config-if)# spanning-tree  
switchA(config-if)#
```

3. Testing configuration result. The port 1 of switch D is blocked. The network structure is tree type.

Case 9 MSTP multi-instance mapping VLAN configuration

Enable MSTP for switch A, switch B, switch C and switch D. To realize the load sharing of VLAN10 and VLAN20, MSTP introduces multiple instances. The MSTP can set up the VLAN mapping table, associating the VLAN with the STP instance, instance 1 mapping to VLAN10, instance 2 mapping to VLAN20. And the switch defaults to instance 0.

1. Topology

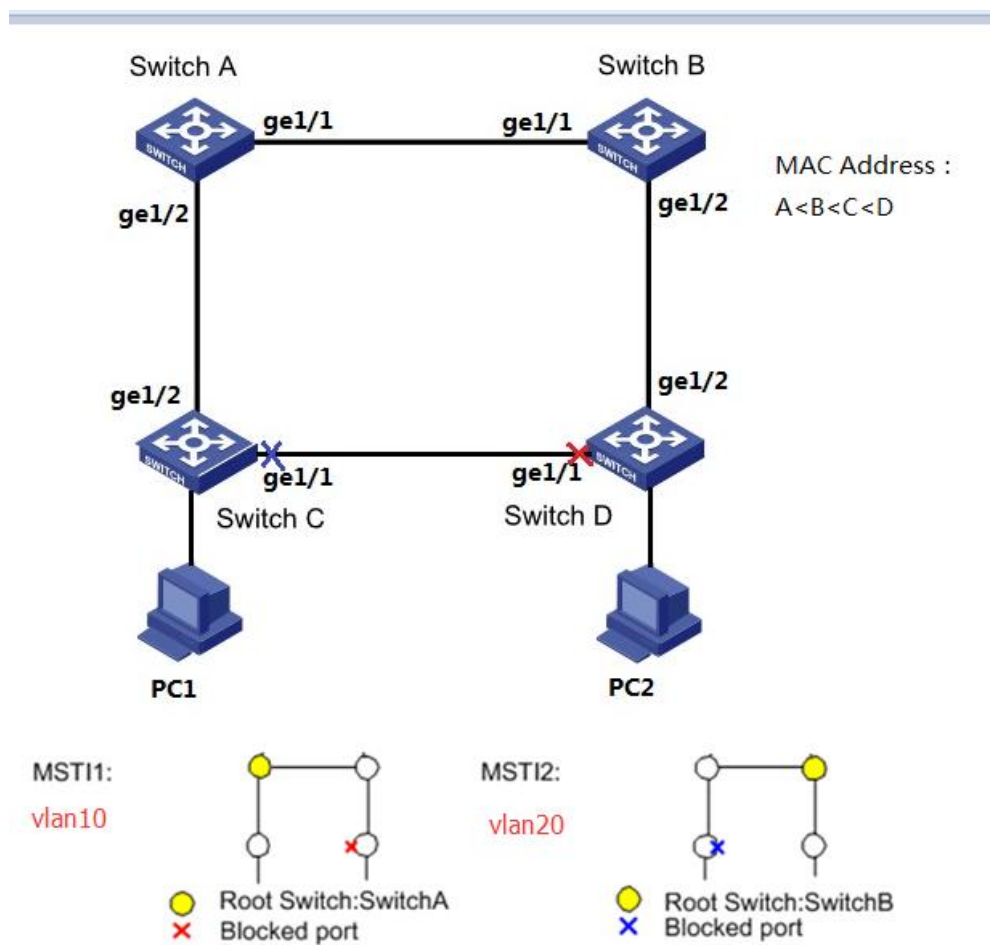

2. Switch Configuration

A. Configure the L2 forwarding function of the device in the looped network, and create VLAN10, vlan20, on the Switch A, Switch B, Switch C and Switch D. Set the switch port connected with lopped network to Trunk mode

```
switchA# con t
```

```
switchA(config)# vlan 10
switchA(config-vlan)# exit
switchA(config)# vlan 20
switchA(config-vlan)#
switchA (config)# int GigabitEthernet 1/1-2
switchA(config-if)#switchport mode trunk
switchA(config-if)#
```

B. Enable STP under global mode for switch A. Same configuration step for switch B, switch C, switch D.

```
switchA#
switchA# con t
switchA(config)# spanning-tree mode mstp
```

C. Enable the MSTP function of PORT1 and PORT2. Same configuration step for Switch B, Switch C and Switch D.

```
switchA (config)# int GigabitEthernet 1/1-2
switchA(config-if)# spanning-tree
switchA(config-if)#
```

D. Configure switch A's instance MSTI1 and MSTI2, MSTI1 mapping vlan10, MSTI1 mapping vlan20. Same configuration step for switch B, switch C and switch D. Shown as below.

```
switchA (config)# spanning-tree mst name mstp revision 0
switchA (config)# spanning-tree mst 1 vlan 10
switchA (config)# spanning-tree mst 2 vlan 20
```

E. Configure root bridge and root bridge backup of MSTI 1 and MSTI 2 under MSTP. Set switch A as the root bridge of MSTI 1 and switch B as the back root bridge of MSTI 2. When configuring switch A, set the priority level of MSTI 1 to 0 and priority level of MSTI 2 to 4096. And when configuring switch B, set priority level of MSTI 1 to 4096 and priority level of MSTI 2 to 0.

```
switchA (config)# spanning-tree mst 1 priority 0
```

```
switchA (config)# spanning-tree mst 2 priority 4096
```

```
switchB (config)# spanning-tree mst 1 priority 4096
```

```
switchB (config)# spanning-tree mst 2 priority 0
```

F. After above configuration, the network structure would be tree type.